

## LA STILLA MONOPOINT SUSPENSION

### D141234-

base number      Color      Finish      Finish  
 Temperature      Options      Options

- To build a product code in our configurator select the specify button on the base model # product page
- To build a manual product code on this datasheet choose from the options listed below in blue font and add the suffix to the base model #

#### GENERAL

Series: La Stilla  
 Subseries: La Stilla Monopoint  
 Brand: Cangini & Tucci  
 Division: Design  
 Mounting Type: Suspension  
 Mounting Location: Ceiling  
 Subcategory: Pendant

#### PHYSICAL

Shape: Sphere  
 Diameter (mm): 200  
 Diameter (in): 7 <sup>7</sup>/<sub>8</sub>  
 Height (mm): 220  
 Height (in): 8 <sup>11</sup>/<sub>16</sub>  
 Max. Overall Height (mm): 2220  
 Max. Overall Height (in): 86 <sup>5</sup>/<sub>8</sub>  
 Light Distribution: Omnidirectional  
 Diffuser: Glass - Opal  
 Fixture Finish: [AMB](#) / [GRN](#) / [PNK](#) / [RUB](#) / [SKB](#) / [SMK](#) / [TOB](#) / [TRA](#)  
 Holder Finish: [CHR](#) / [MWH](#) / [MBK](#) / [BCR](#)  
 Fixture Material: Glass / Metal  
 Cable Details: 2000mm / 78 3/4" Transparent Cable  
 Upon Request: Finishes - Pearl Gold

#### ELECTRICAL

Lamp Type: LED  
 Input Wattage (W): 8.4  
 Dimming: Non-Dimming / Phase Dimming (120vac Only)  
 Driver Included: Yes  
 Driver Location: Integrated  
 Driver Type: Constant Current - 120Vac  
 Driver Class: Class 2  
 Input Voltage (V): 120  
 Constant Current (MA): 350mA  
 Upon Request: 0-10V Dimming

#### LED

Color Temperature (°K): [2700](#) / [3000](#)  
 Nominal Lumen (lm): 1202  
 CRI: >95 CRI  
 Lamp Life (hrs): 50000

#### OPTICAL

#### RATINGS AND CERTIFICATIONS

Certified By: Certified for North American Standards  
 IP rating: IP20

PROJECT
TYPE
SPECIFIER
QUANTITY
DATE



## LA STILLA MONOPOINT SUSPENSION

D141234-

PROJECT

TYPE

SPECIFIER

QUANTITY

DATE



D

## LA STILLA MONOPOINT SUSPENSION

### D141236-

base number      Color      Finish      Finish  
 Temperature      Options      Options

- To build a product code in our configurator select the specify button on the base model # product page
- To build a manual product code on this datasheet choose from the options listed below in blue font and add the suffix to the base model #

#### GENERAL

Series: La Stilla  
 Subseries: La Stilla Monopoint  
 Brand: Cangini & Tucci  
 Division: Design  
 Mounting Type: Suspension  
 Mounting Location: Ceiling  
 Subcategory: Pendant

#### PHYSICAL

Shape: Sphere  
 Diameter (mm): 300  
 Diameter (in): 11 <sup>13</sup>/<sub>16</sub>"  
 Height (mm): 320  
 Height (in): 12 <sup>5</sup>/<sub>8</sub>"  
 Max. Overall Height (mm): 2280  
 Max. Overall Height (in): 91 <sup>5</sup>/<sub>16</sub>"  
 Light Distribution: Omnidirectional  
 Diffuser: Glass - Opal  
 Fixture Finish: [AMB](#) / [GRN](#) / [PNK](#) / [RUB](#) / [SKB](#) / [SMK](#) / [TOB](#) / [TRA](#)  
 Holder Finish: [CHR](#) / [MWH](#) / [MBK](#) / [BCR](#)  
 Fixture Material: Glass / Metal  
 Cable Details: 2000mm / 78 3/4" Transparent Cable  
 Upon Request: Finishes - Pearl Gold

#### ELECTRICAL

Lamp Type: LED  
 Input Wattage (W): 14  
 Total Output Wattage (W): 12  
 Dimming: Non-Dimming / Phase Dimming (120vac Only)  
 Driver Included: Yes  
 Driver Location: Integrated  
 Driver Type: Constant Current - 120Vac  
 Driver Class: Class 2  
 Input Voltage (V): 120  
 Constant Current (MA): 350mA  
 Upon Request: 0-10V Dimming

#### LED

Color Temperature (°K): [2700](#) / [3000](#)  
 Nominal Lumen (lm): 1615  
 CRI: >95 CRI  
 Lamp Life (hrs): 50000

#### OPTICAL

#### RATINGS AND CERTIFICATIONS

Certified By: Certified for North American Standards  
 IP rating: IP20

PROJECT
TYPE
SPECIFIER
QUANTITY
DATE

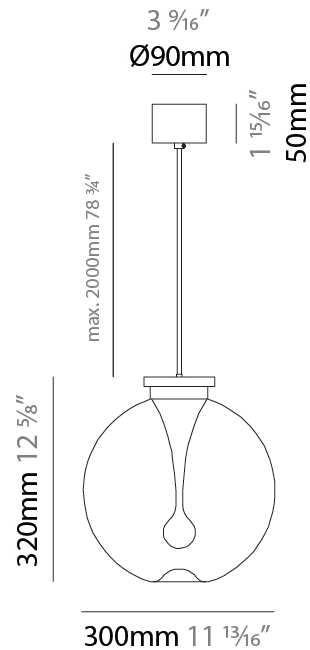

## LA STILLA MONOPOINT SUSPENSION

D141236-

PROJECT

TYPE

SPECIFIER

QUANTITY

DATE



D



PROJECT
TYPE
SPECIFIER
QUANTITY
DATE

## LA STILLA MODULAR SYSTEM SUSPENSION

### D141260-

base number      Color      Finish      Finish  
 Temperature      Options      Options

- To build a product code in our configurator select the specify button on the base model # product page
- To build a manual product code on this datasheet choose from the options listed below in blue font and add the suffix to the base model #

#### GENERAL

Series: La Stilla  
 Subseries: La Stilla Modular System  
 Brand: Cangini & Tucci  
 Division: Design  
 Mounting Type: Suspension  
 Mounting Location: Ceiling  
 Subcategory: Pendant

#### PHYSICAL

Shape: Sphere  
 Diameter (mm): 200  
 Diameter (in): 7 7/8  
 Height (mm): 220  
 Height (in): 8 11/16  
 Max. Overall Height (mm): 2220  
 Max. Overall Height (in): 86 5/8  
 Light Distribution: Omnidirectional  
 Diffuser: Glass - Opal  
 Fixture Finish: [AMB / GRN / PNK / RUB / SKB / SMK / TOB / TRA](#)  
 Holder Finish: CHR / MWH / MBK / BCR  
 Fixture Material: Glass / Metal  
 Cable Details: 2000mm / 78 3/4" Transparent Cable  
 Upon Request: Finishes - Pearl Gold

#### ELECTRICAL

Lamp Type: LED  
 Input Wattage (W): 8.4  
 Dimming: Non-Dimming / Phase Dimming (120vac Only)  
 Driver Included: No  
 Input Voltage (V): 120  
 Constant Current (MA): 350mA  
 Upon Request: 0-10V Dimming

#### LED

Color Temperature (°K): [2700 / 3000](#)  
 Nominal Lumen (lm): 1202  
 CRI: >95 CRI  
 Lamp Life (hrs): 50000

#### OPTICAL

#### RATINGS AND CERTIFICATIONS

Certified By: Certified for North American Standards  
 IP rating: IP20

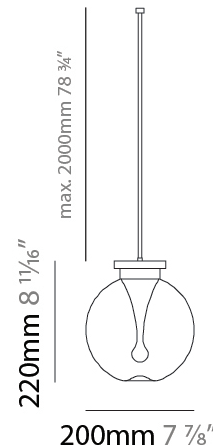

## LA STILLA MODULAR SYSTEM SUSPENSION

D141260-

PROJECT \_\_\_\_\_

TYPE \_\_\_\_\_

SPECIFIER \_\_\_\_\_

QUANTITY \_\_\_\_\_

DATE \_\_\_\_\_

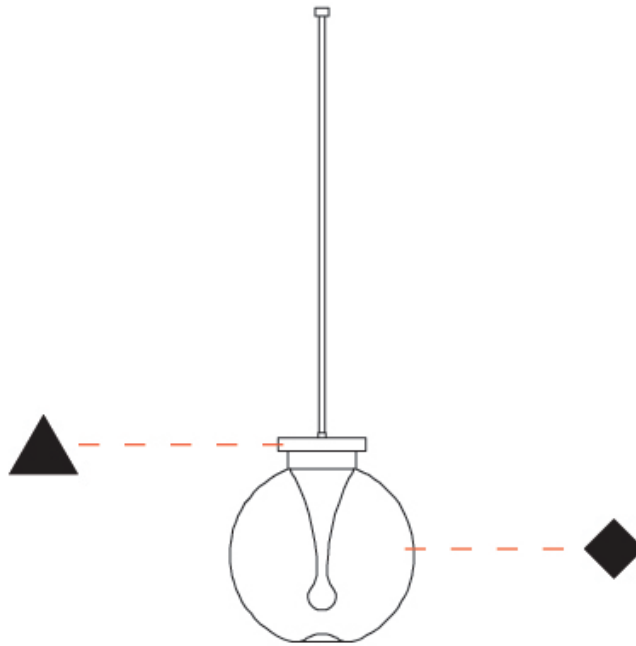

D

PROJECT
TYPE
SPECIFIER
QUANTITY
DATE

## LA STILLA MONOPOINT SUSPENSION

### D141262-

base number	Color Temperature	Finish Options	Finish Options
-------------	----------------------	-------------------	-------------------

- To build a product code in our configurator select the specify button on the base model # product page
- To build a manual product code on this datasheet choose from the options listed below in blue font and add the suffix to the base model #

#### GENERAL

Series: La Stilla
Subseries: La Stilla Monopoint
Brand: Cangini & Tucci
Division: Design
Mounting Type: Suspension
Mounting Location: Ceiling
Subcategory: Pendant

#### PHYSICAL

Shape: Sphere
Diameter (mm): 300
Diameter (in): 11 <sup>13</sup> / <sub>16</sub>
Height (mm): 320
Height (in): 12 <sup>5</sup> / <sub>8</sub>
Max. Overall Height (mm): 2280
Max. Overall Height (in): 91 <sup>5</sup> / <sub>16</sub>
Light Distribution: Omnidirectional
Diffuser: Glass - Opal
Fixture Finish: <a href="#">AMB</a> / <a href="#">GRN</a> / <a href="#">PNK</a> / <a href="#">RUB</a> / <a href="#">SKB</a> / <a href="#">SMK</a> / <a href="#">TOB</a> / <a href="#">TRA</a>
Holder Finish: <a href="#">CHR</a> / <a href="#">MWH</a> / <a href="#">MBK</a> / <a href="#">BCR</a>
Fixture Material: Glass / Metal
Cable Details: 2000mm / 78 3/4" Transparent Cable
Upon Request: Finishes - Pearl Gold

#### ELECTRICAL

Lamp Type: LED
Input Wattage (W): 14
Total Output Wattage (W): 12
Dimming: Non-Dimming / Phase Dimming (120vac Only)
Driver Included: No
Input Voltage (V): 120
Constant Current (MA): 350mA
Upon Request: 0-10V Dimming

#### LED

Color Temperature (°K): <a href="#">2700</a> / <a href="#">3000</a>
Nominal Lumen (lm): 1615
CRI: >95 CRI
Lamp Life (hrs): 50000

#### OPTICAL

#### RATINGS AND CERTIFICATIONS

Certified By: Certified for North American Standards
IP rating: IP20

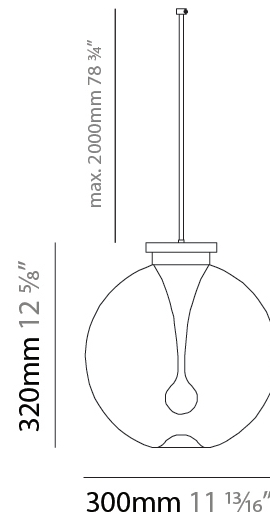

## LA STILLA MONOPOINT SUSPENSION

D141262-

PROJECT \_\_\_\_\_

TYPE \_\_\_\_\_

SPECIFIER \_\_\_\_\_

QUANTITY \_\_\_\_\_

DATE \_\_\_\_\_



D

PROJECT	_____
TYPE	_____
SPECIFIER	_____
QUANTITY	_____
DATE	_____

## LA STILLA 3 LIGHT LINEAR SUSPENSION

### D141263-

base number	Color	Finish	Finish
	Temperature	Options	Options

- To build a product code in our configurator select the specify button on the base model # product page
- To build a manual product code on this datasheet choose from the options listed below in blue font and add the suffix to the base model #

#### GENERAL

Series: La Stilla
Subseries: La Stilla 3 Light Linear
Brand: Cangini & Tucci
Division: Design
Mounting Type: Suspension
Mounting Location: Ceiling
Subcategory: Pendant

#### PHYSICAL

Shape: Sphere
Length (mm): 1200
Length (in): 47 1/4
Height (mm): 220
Height (in): 8 11/16
Max. Overall Height (mm): 2220
Max. Overall Height (in): 86 5/8
Light Distribution: Omnidirectional
Diffuser: Glass - Opal
Fixture Finish: <a href="#">AMB</a> / <a href="#">GRN</a> / <a href="#">PNK</a> / <a href="#">RUB</a> / <a href="#">SKB</a> / <a href="#">SMK</a> / <a href="#">TOB</a> / <a href="#">TRA</a>
Holder Finish: <a href="#">CHR</a> / <a href="#">MWH</a> / <a href="#">MBK</a> / <a href="#">BCR</a>
Fixture Material: Glass / Metal
Cable Details: 2000mm / 78 3/4" Transparent Cable
Upon Request: Finishes - Pearl Gold

#### ELECTRICAL

Lamp Type: LED
Input Wattage (W): 25.2
Dimming: Non-Dimming / Phase Dimming (120vac Only)
Driver Included: Yes
Driver Location: Integrated
Driver Type: Constant Current - 120Vac
Driver Class: Class 2
Input Voltage (V): 120
Constant Current (MA): 350mA
Upon Request: 0-10Vdc dimming

#### LED

Color Temperature (°K): <a href="#">2700</a> / <a href="#">3000</a>
Nominal Lumen (lm): 4845
CRI: >95 CRI
Lamp Life (hrs): 50000

#### OPTICAL

#### RATINGS AND CERTIFICATIONS

Certified By: Certified for North American Standards
IP rating: IP20

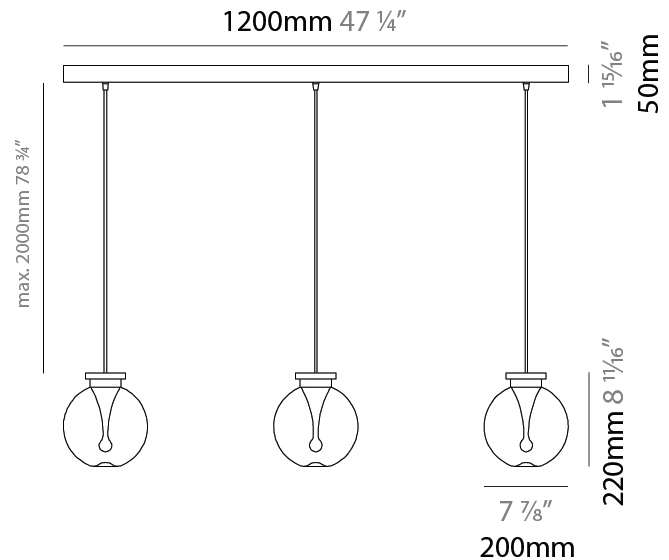

## LA STILLA 3 LIGHT LINEAR SUSPENSION

D141263-

PROJECT	_____
TYPE	_____
SPECIFIER	_____
QUANTITY	_____
DATE	_____

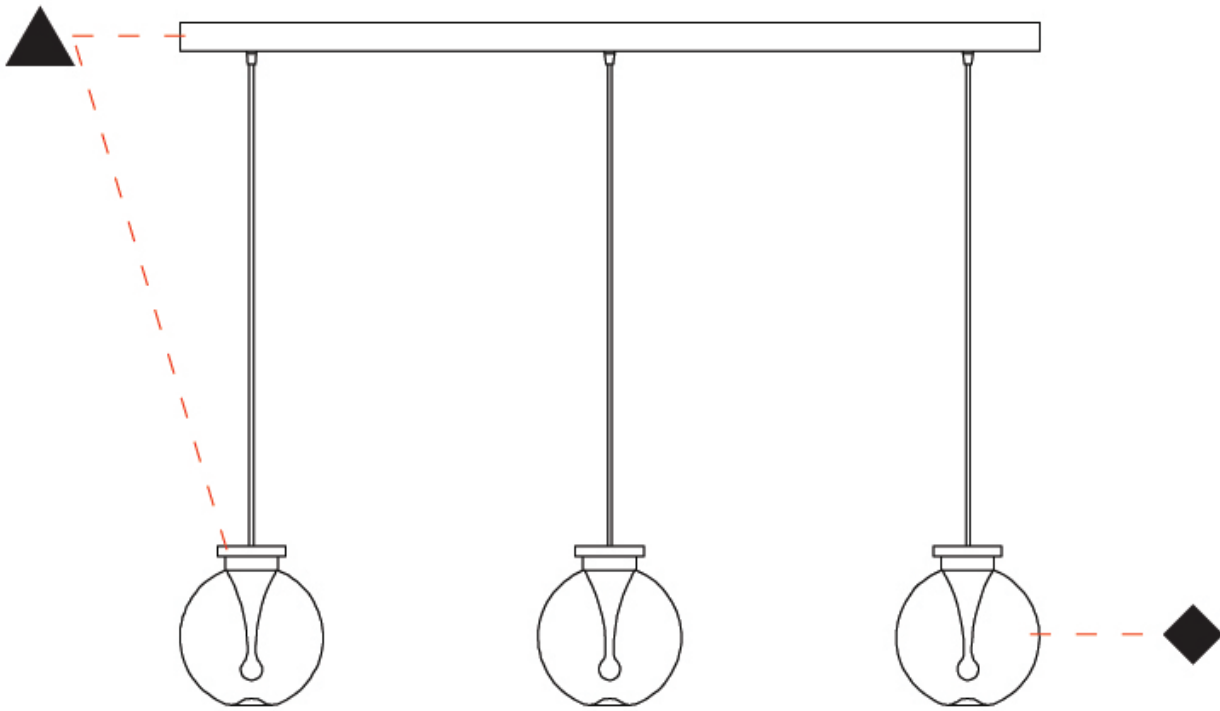

D

PROJECT	
TYPE	
SPECIFIER	
QUANTITY	
DATE	

## LA STILLA 3 LIGHT CLUSTERS SUSPENSION

### D141264-

base number	Color	Finish	Finish
	Temperature	Options	Options

- To build a product code in our configurator select the specify button on the base model # product page
- To build a manual product code on this datasheet choose from the options listed below in blue font and add the suffix to the base model #

#### GENERAL

Series: La Stilla
Subseries: La Stilla 3 Light Clusters
Brand: Cangini & Tucci
Division: Design
Mounting Type: Suspension
Mounting Location: Ceiling
Subcategory: Pendant

#### PHYSICAL

Shape: Sphere
Diameter (mm): 430
Diameter (in): 16 <sup>15</sup> / <sub>16</sub>
Height (mm): 220
Height (in): 8 <sup>11</sup> / <sub>16</sub>
Max. Overall Height (mm): 2220
Max. Overall Height (in): 86 <sup>5</sup> / <sub>8</sub>
Light Distribution: Omnidirectional
Diffuser: Glass - Opal
Fixture Finish: <a href="#">AMB</a> / <a href="#">GRN</a> / <a href="#">PNK</a> / <a href="#">RUB</a> / <a href="#">SKB</a> / <a href="#">SMK</a> / <a href="#">TOB</a> / <a href="#">TRA</a>
Holder Finish: <a href="#">CHR</a> / <a href="#">MWH</a> / <a href="#">MBK</a> / <a href="#">BCR</a>
Fixture Material: Glass / Metal
Cable Details: 2000mm / 78 3/4" Transparent Cable
Upon Request: Finishes - Pearl Gold

#### ELECTRICAL

Lamp Type: LED
Input Wattage (W): 25.2
Dimming: Non-Dimming / Phase Dimming (120vac Only)
Driver Included: Yes
Driver Location: Integrated
Driver Type: Constant Current - 120Vac
Driver Class: Class 2
Input Voltage (V): 120
Constant Current (MA): 350mA
Upon Request: 0-10Vdc dimming

#### LED

Color Temperature (*K): <a href="#">2700</a> / <a href="#">3000</a>
Nominal Lumen (lm): 4845
CRI: >95 CRI

#### OPTICAL

#### RATINGS AND CERTIFICATIONS

Certified By: Certified for North American Standards
IP rating: IP20

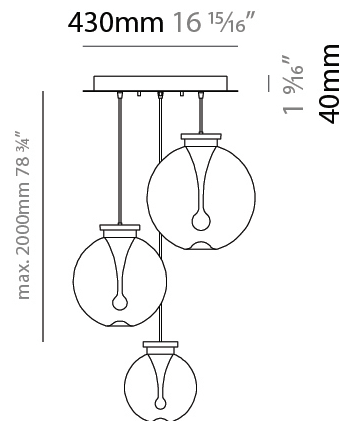

## LA STILLA 3 LIGHT CLUSTERS SUSPENSION

D141264-

PROJECT \_\_\_\_\_

TYPE \_\_\_\_\_

SPECIFIER \_\_\_\_\_

QUANTITY \_\_\_\_\_

DATE \_\_\_\_\_

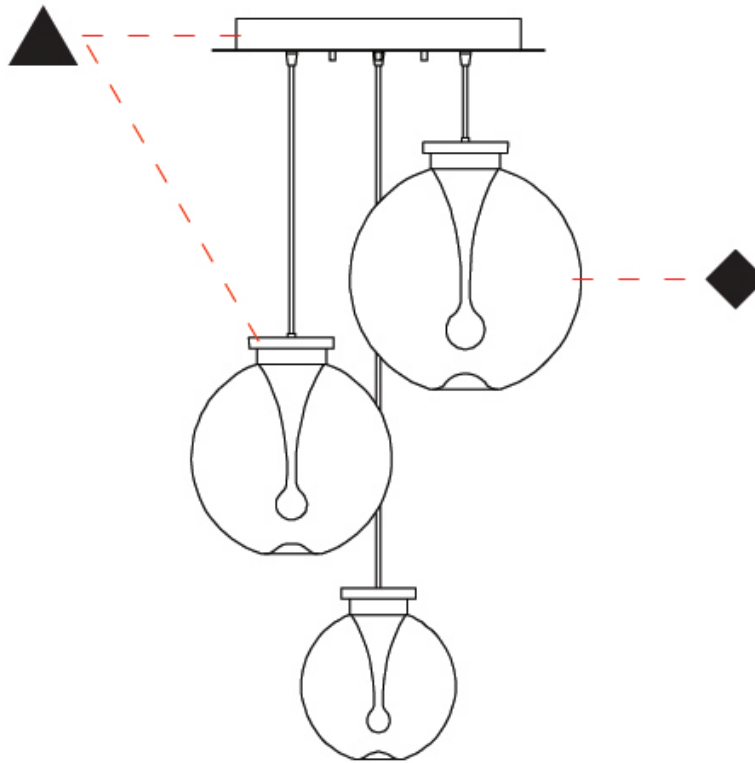

D



## LA STILLA SURFACE

### D142014-

base number      Color      Finish      Finish  
 Temperature      Options      Options

- To build a product code in our configurator select the specify button on the base model # product page
- To build a manual product code on this datasheet choose from the options listed below in blue font and add the suffix to the base model #

#### GENERAL

Series: La Stilla  
 Brand: Cangini & Tucci  
 Division: Design  
 Mounting Type: Surface  
 Mounting Location: Ceiling  
 Subcategory: Flush Mount

#### PHYSICAL

Shape: Sphere  
 Diameter (mm): 260  
 Diameter (in): 7 7/8  
 Height (mm): 300  
 Height (in): 8 11/16  
 Light Distribution: Omnidirectional  
 Diffuser: Glass - Opal  
 Fixture Finish: [AMB](#) / [GRN](#) / [PNK](#) / [RUB](#) / [SKB](#) / [SMK](#) / [TOB](#) / [TRA](#)  
 Holder Finish: [CHR](#) / [MWH](#) / [MBK](#) / [BCR](#)  
 Fixture Material: Glass / Metal  
 Upon Request: Finishes - Pearl Gold

#### ELECTRICAL

Lamp Type: LED  
 Input Wattage (W): 14  
 Total Output Wattage (W): 12  
 Dimming: Non-Dimming / Phase Dimming (120vac Only)  
 Driver Included: Yes  
 Driver Location: Integrated  
 Driver Type: Constant Current - 120Vac  
 Driver Class: Class 2  
 Input Voltage (V): 120  
 Constant Current (MA): 350mA  
 Upon Request: Remote: 0-10Vdc dimming / Non-dimming 120/277Vac

#### LED

Color Temperature (°K): [2700](#) / [3000](#)  
 Nominal Lumen (lm): 1615  
 CRI: >95 CRI  
 Lamp Life (hrs): 50000

#### OPTICAL

#### RATINGS AND CERTIFICATIONS

Certified By: Certified for North American Standards  
 IP rating: IP20

PROJECT
TYPE
SPECIFIER
QUANTITY
DATE

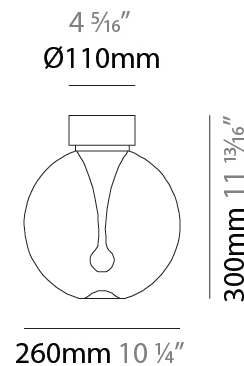

D142014-

PROJECT

TYPE

SPECIFIER

QUANTITY

DATE

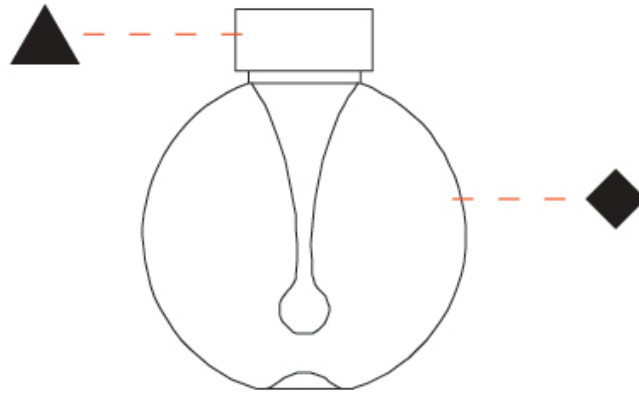

## LA STILLA SURFACE

### D142015-

base number      Color      Finish      Finish  
 Temperature      Options      Options

- To build a product code in our configurator select the specify button on the base model # product page
- To build a manual product code on this datasheet choose from the options listed below in blue font and add the suffix to the base model #

#### GENERAL

Series: La Stilla  
 Brand: Cangini & Tucci  
 Division: Design  
 Mounting Type: Surface  
 Mounting Location: Ceiling  
 Subcategory: Flush Mount

#### PHYSICAL

Shape: Sphere  
 Diameter (mm): 300  
 Diameter (in): 8 <sup>11</sup>/<sub>16</sub>  
 Height (mm): 350  
 Height (in): 13 <sup>3</sup>/<sub>4</sub>  
 Light Distribution: Omnidirectional  
 Diffuser: Glass - Opal  
 Fixture Finish: [AMB / GRN / PNK / RUB / SKB / SMK / TOB / TRA](#)  
 Holder Finish: [CHR / MWH / MBK / BCR](#)  
 Fixture Material: Glass / Metal  
 Upon Request: Finishes - Pearl Gold

#### ELECTRICAL

Lamp Type: LED  
 Input Wattage (W): 14  
 Total Output Wattage (W): 12  
 Dimming: Non-Dimming / Phase Dimming (120vac Only)  
 Driver Included: Yes  
 Driver Location: Integrated  
 Driver Type: Constant Current - 120Vac  
 Driver Class: Class 2  
 Input Voltage (V): 120  
 Constant Current (mA): 350mA  
 Upon Request: Remote: 0-10Vdc dimming / Non-dimming 120/277Vac

#### LED

Color Temperature (°K): [2700 / 3000](#)  
 Nominal Lumen (lm): 1615  
 CRI: >95 CRI  
 Lamp Life (hrs): 50000

#### OPTICAL

#### RATINGS AND CERTIFICATIONS

Certified By: Certified for North American Standards  
 IP rating: IP20

PROJECT
TYPE
SPECIFIER
QUANTITY
DATE

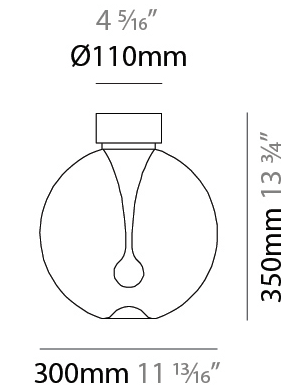

D142015-

PROJECT

TYPE

SPECIFIER

QUANTITY

DATE

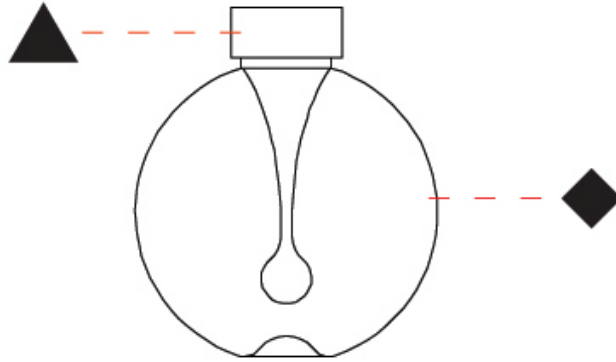

D

PROJECT
TYPE
SPECIFIER
QUANTITY
DATE

## LA STILLA SURFACE

### D143033-

base number    Color    Finish    Finish  
 Temperature    Options    Options

- To build a product code in our configurator select the specify button on the base model # product page
- To build a manual product code on this datasheet choose from the options listed below in blue font and add the suffix to the base model #

#### GENERAL

Series: La Stilla  
 Brand: Cangini & Tucci  
 Division: Design  
 Mounting Type: Surface  
 Mounting Location: Ceiling  
 Subcategory: Flush Mount

#### PHYSICAL

Shape: Sphere  
 Diameter (mm): 200  
 Diameter (in): 7 7/8  
 Height (mm): 250  
 Height (in): 9 13/16  
 Light Distribution: Omnidirectional  
 Diffuser: Glass - Opal  
 Fixture Finish: [AMB / GRN / PNK / RUB / SKB / SMK / TOB / TRA](#)  
 Holder Finish: CHR / MWH / MBK / BCR  
 Fixture Material: Glass / Metal  
 Upon Request: Finishes - Pearl Gold

#### ELECTRICAL

Lamp Type: LED  
 Input Wattage (W): 8.4  
 Dimming: Non-Dimming / Phase Dimming (120vac Only)  
 Driver Included: Yes  
 Driver Location: Integrated  
 Driver Type: Constant Current - 120Vac  
 Driver Class: Class 2  
 Input Voltage (V): 120  
 Constant Current (MA): 350mA

#### LED

Color Temperature (°K): [2700 / 3000](#)  
 Nominal Lumen (lm): 1615  
 CRI: >95 CRI  
 Lamp Life (hrs): 50000

#### OPTICAL

#### RATINGS AND CERTIFICATIONS

Certified By: Certified for North American Standards  
 IP rating: IP20

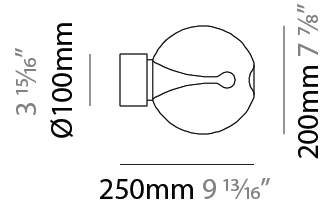

D143033-

PROJECT

TYPE

SPECIFIER

QUANTITY

DATE

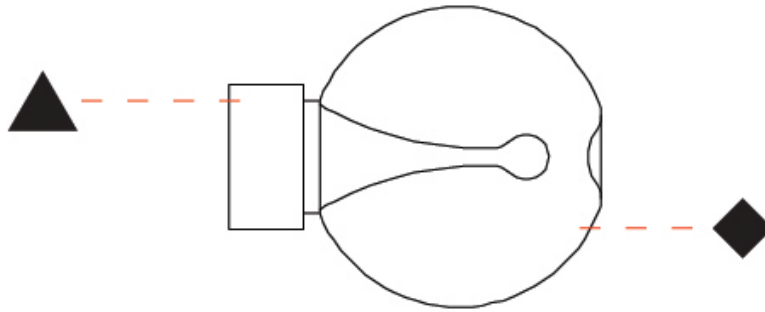

D

PROJECT	_____
TYPE	_____
SPECIFIER	_____
QUANTITY	_____
DATE	_____

### Fixture Finish

Amber - AMB



Green - GRN



Pink - PNK



Ruby - RUB



Sky Blue - SKB



Smoke - SMK



Tobacco - TOB



Transparent - TRA



### Holder Finish

Chrome - CHR



Matte White - MWH



Matte Black - MBK



Brushed Chrome - BCR



**Digital:** Not all screens are calibrated the same, and therefore, colors will appear differently between screens.

**Physical:** When texture is involved, there will be variations in color, character and tone within a product series and between product families.

### LEGEND

	floor-mounted		pivotal		special LED (upon request) RGB, RGBW, tunable, gold+, meat+, art+, fashion+
	wall and ceiling: recessed and surface mounted		rotating		warm dim / natural dimming LED
	ceiling-mounted and wall-mounted		illuminate tilted		rechargeable battery powered
	wall-mounted		color of suspension cable		fixture with natural vivid LED (upon request)
	omni-directional light distribution		length of suspension cable		color rendering index
	direct light distribution		reflector degree selection		color temperature
	direct/indirect light distribution		super spot		lumen (luminous flux)
	indirect light distribution		lens		efficacy (lumens per watt)
	asymmetric light distribution		lens pack		Unified Glare Rating (UGR) range from 5-40
	aura light distribution		shine ring		marine grade (AISI 316 stainless steel)
	round wall or ceiling cut-out		integrated shine ring with diffuser		walk on
	square wall or ceiling cut-out		free individual colors 01-29		drive on
	the supplied jig specifies the cutout dimensions		individual colors: 00 (free of charge), 01-25 (extra charge)		Dark Sky Compliance
	minimum distance (meters) lamp - object		luminaire part to be colored (F1)		Americans with Disabilities Act (less than 4" off the wall located between 27"-84" from floor)
	recessed depth		luminaire part to be colored (F2)		lamp protected against explosion
	ceiling thickness in mm		luminaire part to be colored (F3)		blown glass using traditional methods by master glass blower
	ceiling thickness selection		luminaire part to be colored (F4)		acoustic material
	dimnable DP (phase), DV (0-10V), DD (dali), DS (step-dim)		luminaire part to be colored (F5)		protection class I, protection insulation
	included or excluded LED driver/transformer/control gear		color of 3-circuit adaptor		protection class II, protection insulation
	separately switchable		indirect diffuser		ETL Certified to UL and CSA Standards
	sensor		direct diffuser		UL Certified to UL and CSA Standards
	remote control		ball-proof (upon request)		CSA Certified to UL and CSA Standards
	available upon request		accessory		Certified for North American Standards

### IP RATING

	protected against ingress of solid bodies greater than 12.5mm (finger)
	protected against ingress of solid bodies greater than 2.5mm protected against sprays of water up to 60 degrees from the vertical (rain)
	protected against ingress of solid bodies greater than 1mm (wire) no protection against the ingress of moisture
	protected against ingress of solid bodies greater than 1mm (wire) protected against sprays of water up to 60 degrees from the vertical (rain)
	protected against ingress of solid bodies greater than 1mm (wire) protected against water splashed from all directions
	protected against limited ingress of dust (wet rooms/covered outdoor areas) protected against water splashed from all directions
	protected against ingress of dust protected against jets of water
	protected against ingress of dust protected against powerful jets of water or heavy seas
	protected against ingress of dust protected against immersion of water between 15cm - 1m for 30 minutes
	protected against ingress of dust protected against immersion of water under pressure for long periods

### IK RATING

	protected against 0.14 joules impact (equivalent to 0.25kg mass dropped from 56mm above the surface)
	protected against 0.2 joules impact (equivalent to 0.25kg mass dropped from 80mm above the surface)
	protected against 0.35 joules impact (equivalent to 0.25kg mass dropped from 140mm above the surface)
	protected against 0.5 joules impact (equivalent to 0.25kg mass dropped from 200mm above the surface)
	protected against 0.7 joules impact (equivalent to 0.25kg mass dropped from 280mm above the surface)
	protected against 1 joules impact (equivalent to 0.25kg mass dropped from 400mm above the surface)
	protected against 2 joules impact (equivalent to 0.5kg mass dropped from 400mm above the surface)
	protected against 5 joules impact (equivalent to 1.7kg mass dropped from 300mm above the surface)
	protected against 10 joules impact (equivalent to 5.0kg mass dropped from 200mm above the surface)
	protected against 20 joules impact (equivalent to 5.0kg mass dropped from 400mm above the surface)